

Dati Tecnici Contenitore Antideflagrante

Classificazione ATEX	II 2 G Ex-d IIC T6
Temperatura ambiente	-20°C +40°C
Protezione	IP65 vedi pagina 8
Materiale	lega primaria di alluminio

Explosion-Resistant Box Specifications

ATEX approval	II 2 G Ex-d IIC T6
Temperature conditions	-20°C to +40°C
Protection	IP65 see page 8
Material	primary aluminium alloy

Dati Tecnici Pressostato

Campo di lavoro	0,2...300 bar (secondo modello scelto)
Differenziale	per 10% al 30% del valore di taratura
Portata contatti	6(2)A/250 Vca
Campo di temperatura	-20°C...+40°C
Pressione massima	80...600 bar (secondo modello scelto)
Numero max. interventi a 25°C	120/min (membrana)
Numero max. interventi a 25°C	60/min (membrana)
Vita meccanica	10 ⁶ cicli
Contatto elettrico	SPDT
Materiale corpo	ottone, acciaio tropicalizzato, acciaio inox 316
Materiale membrana/guarnizione pistone	NBR, HNBR, FKM, Silicone, Neoprene, EPDM

Pressure Switch Specifications

Adjustment range	0,2...300 bar (according to model required)
Hysteresis	from 10% to 30% of set-point value
Switch rating	6(2)A/250 Vac
Temperature range	-20°C to +40°C
Max pressure	80...600 bar (according to model required)
Max cycle rate at 25°C	120/min operations (diaphragm)
Max. cycle rate at 25°C	60/min operations (piston)
Mechanical life	10 ⁶ operations
Contact	SPDT
Body materials	brass, zinc plated steel, stainless steel 316
Diaphragm/Piston gasket materials	NBR, HNBR, FKM, Silicone, Neoprene, EPDM



SIGLA DI ORDINAZIONE / HOW TO ORDER

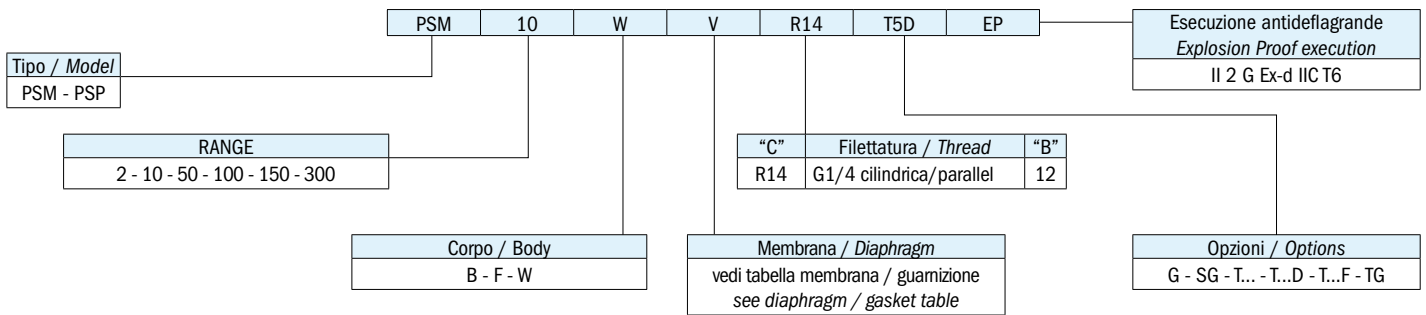

SPIEGAZIONE DELLE SIGLE DI ORDINAZIONE / ORDERING INFORMATION

PSM...	Pressostato con contatti SPDT a membrana
PSP...	Pressostato con contatti SPDT a pistone
Materiale corpo Ch27	B Ottone F Acciaio zincato W AISI 316 a richiesta su tutti i modelli
Membrana disponibile/ Guarnizioni	N NBR (standard) (-5°C...+90°C) NT HNBR (-25°C...+140°C) V FKM (-5°C...+90°C) S Silicene (-30°C...+120°C) C Neoprene (-10°C...+90°C) E EPDM (-20°C...+110°C) MI Acc. Inox (-30°C...+140°C) (solo PSM2 e PSM10)
Filettature disponibili	R14 Filetto G1/4 cilindrico
Opzioni	G Contatti dorati per bassa corrente SG Sgrassati per ossigeno T... Taratura in salita (es. T2 taratura a 2 bar) T...D Taratura in discesa (es. T2D taratura in discesa a 2 bar) T...F Taratura del pressostato e del differenziale se >10% max. 30% valore taratura (es. T40 F10 taratura in salita a 40 bar con differenziale di 10 bar) TARATURA IN ELETTROTEC TG Testati per utilizzo con gas

IN CONFORMITÀ ALLA DIRETTIVA 2014/30/CE.

PSM...	Diaphragm pressure switch with SPDT contacts
PSP...	Piston pressure switch with SPDT contacts
27AF body material	B Brass F Zinc plated steel W S.S. 316 on request for all models
Available diaphragm/ Gasket	N NBR (standard) (-5°C to +90°C) NT HNBR (-25°C to +140°C) V FKM (-5°C to +90°C) S Silicone (-30°C to +120°C) C Neoprene (-10°C to +90°C) E EPDM (-20°C to +110°C) MI Stainless steel (-30°C to +140°C) (only PSM2 and PSM10)
Threads	R14 G1/4 parallel
Options	G Gold-plated contacts for low current SG Degreased for applications with oxygen T... Set-point adjustment rising at the required value (ex. T2 pressure set rising at 2 bar) T...D Set-point adjustment falling at the required value (ex. T2D pressure set falling at 2 bar) T...F... Set-point and hysteresis at the required value if > 10% max 30% of set-point (ex. T40F10 set point at 40 bar with hysteresis at 10 bar) FACTORY SETTING TG Tested for applications with gas

IN COMPLIANCE WITH DIRECTIVE 2014/30/CE.

CARATTERISTICHE GENERALI / GENERAL SPECIFICATIONS













TIPO MODEL	CAMPO DI LAVORO PRESSIONI RELATIVE ADJUSTMENT RELATIVE PRESSURE RANGE bar	DIMENSIONI "A" DIMENSIONS "A" mm	MAX. PRESSIONE STATICA SUPPORTABILE MAX. STATIC PRESSURE bar			TOLLERANZA D'INTERVENTO A 25°C TOLERANCE AT 25°C bar	ESECUZIONE EXECUTION	
			ESEC. CORPO OTTONE EXECUTION BRASS	ESEC. CORPO ACCIAIO AVP ZINC PLATED BODY EXECUTION	ESEC. CORPO ACCIAIO INOX 316 S.S. 316 EXECUTION			
PSM 2...EP	0,2 - 2	165	80	300	150	±0,2	Membrana Diaphragm	
PSM 10...EP	1 - 10		80	300	150	±0,4		
PSM 50...EP	10 - 50		80	300	150	±2		
PSM 100...EP	10 - 100		80	300	150	±3		
PSP 150...EP	30 - 150				600	250	±5	Pistone Piston
PSP 300...EP	50 - 300				600	400	±15	

Elettrotec si riserva la facoltà di apportare modifiche tecniche ai prodotti o di cessarne la produzione senza obbligo di preavviso. Il contatto del pressostato può danneggiarsi quando sottoposto a forti urti o ad alte vibrazioni. È responsabilità dell'utilizzatore verificare l'idoneità dei nostri prodotti per ogni particolare applicazione (ad esempio, la verifica della compatibilità dei materiali) e l'uso può essere appropriato solo se dimostrato in test sul campo. Le informazioni tecniche in questo catalogo si basano su prove effettuate durante lo sviluppo del prodotto e in base ai valori empiricamente raccolti. Essi non possono essere applicabili in tutti i casi.

Elettrotec reserves the right to technical data of change to the products or halt production without prior notice. The pressure switch contacts can be damaged when subject to strong shocks or high vibration. It is the responsibility of the user to test the suitability of our products for the particular application, for example, the verification of material compatibility. The use may only be appropriate if proven in field tests. The technical information in this catalogue are based on tests made during product development and based on empirically gathered values. They may not be applicable in all cases.

PRESSOSTATI / PRESSURE SWITCHES

PROTEZIONI ELETTRICHE / ELECTRIC PROTECTIONS

Pagina / Page			PMN	PMM	PM250	MS	PS	PSM PSP	PMC PMC...D	PPC PPCF	PPC...D PPCF...D	PML	PPL	PSK	MPS	PHP	PHC		
Protezione IP 54 / IP 54 electric protection			9	11	13	15	15	17...26	27	29	29	31	31	33	35	37	39		
CAP 1  CAP 10  CAP 12  CAP 16  CAP 30  CAP 31 		●	●	●													●		
		●	●															●	
								●											
						●	●									●			
																			●
																			●
Protezione IP 65 / IP 65 electric protection																			
CAP 3  CAP 13  Connettore Din 40050 / Din 40050 Connector 		●	●	●														●	
						●	●												
								●	●	●	●	●	●	●	●	●			
Protezione IP 67 / IP 67 electric protection																			
Cap 14 + Cavi + Connettore Cap 14 + Flying Leads + Connector  Connettore M12 / M12 Connector  Deutsch DT04-2P integrato 		●		●	●	●												●	
						●	●	●	●	●	●	●	●	●	●	●			
																	●		

DATI ELETTRICI / ELECTRIC DATA

		PMN	PMM	PM250	MS	PS	PSM PSP	PMC PMC...D	PPC PPCF	PPC...D PPCF...D	PML	PPL	PSK	MPS	PHP	PHC	
Tensione di alimentazione / Power supply	12 Vca/cc	●	●	●	●	●	●	●	●	●	●	●	●	●	●	●	●
	24 Vca/cc	●	●	●	●	●	●	●	●	●	●	●	●	●	●	●	●
	48 Vca/cc	●	●	●	●	●	●	●	●	●	●	●	●	●	●	●	●
	110 Vca/cc			●	●	●	●	●	●	●	●	●	●	●	●	●	●
	220 Vca/cc			●	●	●	●	●	●	●	●	●	●	●	●	●	●
	250 Vca/cc			●	●	●	●	●	●	●	●	●	●	●	●	●	●
Corrente massima / Max. current	< 30 mA	●	●	●	●	●	●	●	●	●	●	●	●	●			
	0,5 A	●	●	●											●		
	3 A							●	●	●	●	●	●				
	4 A																●
	6 A				●	●	●										
	7 A													●			
	8 A																●
	10 A							●	●	●	●	●	●	●			
15 A																●	
Contatti argentati / Silver plated contacts		●	●	●	●	●	●	●	●	●	●	●	●	●	●	●	●
Contatti dorati / Gold plated contacts		●	●	●	●	●	●	●	●	●	●	●	●	●	●	●	●
Isteresi fissa / Fixed Hysteresis		●	●	●	●	●	●	●	●	●	●	●	●	●	●	●	●
Isteresi regolabile / Adjustable Hysteresis							●										
Corpo CH. 24 / Body 24 AF		●	●	●	●	●					●	●		●	●		
Corpo CH. 27 / Body 27 AF							●										

Elettrotec si riserva la facoltà di apportare modifiche tecniche ai prodotti o di cessarne la produzione senza obbligo di preavviso. Il contatto del pressostato può danneggiarsi quando sottoposto a forti urti o ad alte vibrazioni. È responsabilità dell'utilizzatore verificare l'idoneità dei nostri prodotti per ogni particolare applicazione (ad esempio, la verifica della compatibilità dei materiali) e l'uso può essere appropriato solo se dimostrato in test sul campo. Le informazioni tecniche in questo catalogo si basano su prove effettuate durante lo sviluppo del prodotto e in base ai valori empiricamente raccolti. Essi non possono essere applicabili in tutti i casi.

Elettrotec reserves the right to technical data of change to the products or halt production without prior notice. The pressure switch contacts can be damaged when subject to strong shocks or high vibration. It is the responsibility of the user to test the suitability of our products for the particular application, for example, the verification of material compatibility. The use may only be appropriate if proven in field tests. The technical information in this catalogue are based on tests made during product development and based on empirically gathered values. They may not be applicable in all cases.