

最大电压	48 Vac/dc	Max. voltage	48 Vac/dc
电流	0.5 (0.2) A	Current	0.5 (0.2) A
温度范围	-30°C...+140°C (根据膜片材料)	Temperature range	-30°C to +140°C (according to diaphragm material)
25°C 时最大循环速率	200/1'	Max. cycles rate at 25°C	200/min.
防护端子	IP00 见第 58 页	Protection (terminals)	IP00 see page 58
带保护帽 1 和 10 的防护	IP54 见第 58 页	Protection with CAP. 1 - CAP. 10	IP54 see page 58
带保护帽 3 的防护	IP65 见第 58 页	Protection with CAP. 3	IP65 see page 58
开关外壳	尼龙 66	Switch housing	PA 66
机械寿命	10 <sup>6</sup> 循环	Mechanical life	10 <sup>6</sup> operations
强度试验	1500 V - 10 mA - 10"	Strength test	1500 V - 10 mA - 10"
建议拧紧力矩	最大 4 Kgm. 见第 3 页	Recommended tightening torque	Max. 4 Kgm. see page 3

### 保护帽 / PROTECTION CAPS

#### 防护等级 IP 54 / IP 54 PROTECTION

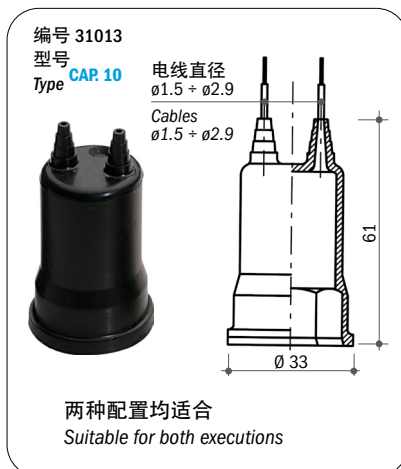
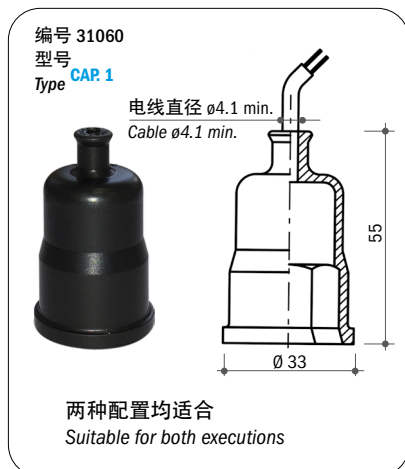

#### 防护等级 IP 65 / IP 65 PROTECTION



### 如何订购 / HOW TO ORDER

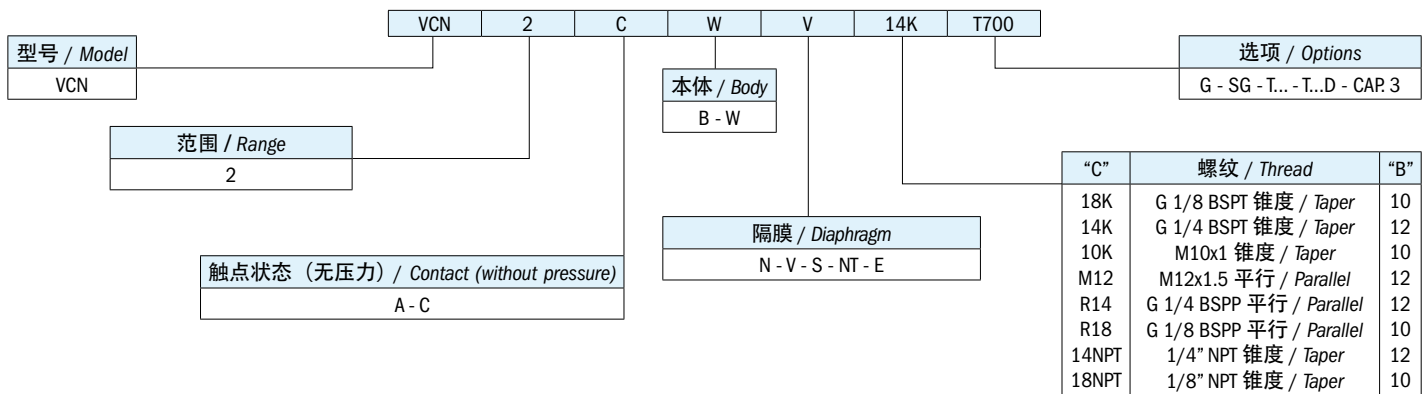

### 订购信息 / ORDERING INFORMATION

VCN	带 FAST-ON 连接端子的真空控制器
触点状态	A 常开触点 C 常闭触点
本体材料 Ch 24 (见一般规格)	B 黄铜 W 316 不锈钢配置本体
可用隔膜 / 密封垫	N NBR (-5°C...+60°C) V FKM (-5°C...+90°C) S 硅胶 (-30°C...+120°C) NT HNBR (-25°C...+140°C) E EPDM (-20°C...+120°C)
可用螺纹	18K G 1/8 BSPT 锥度 14K G 1/4 BSPT 锥度 10K M10x1 锥度 M12 M12x1.5 平行 R14 G 1/4 BSPP 平行 R18 G 1/8 BSPP 平行 14NPT 1/4" NPT 锥度 18NPT 1/8" NPT 锥度
选项	G 用于低电流的镀金触点 SG 脱脂应用于氧气 T... 调节向上设定点到所需值 (如: -500 mbar) T...D 调节向下设定点到所需值 (如: -750 mbar) CAP. 3 适合配置保护帽 3

VCN	Vacuum controller with push-on terminals 6.3x0.8
Contact type	A NO normally open C NC normally closed
24 AF body material (see general specifications)	B Brass W S.s. 316
Available diaphragm/ seal	N NBR (-5°C to +60°C) V FKM (-5°C to +90°C) S Silicone (-30°C to +120°C) NT HNBR (-25°C to +140°C) E EPDM (-20°C to +120°C)
Available threads	18K G 1/8 BSPT taper 14K G 1/4 BSPT taper 10K M10x1 taper M12 M12x1.5 parallel R14 G 1/4 BSPP parallel R18 G 1/8 BSPP parallel 14NPT 1/4" NPT taper 18NPT 1/8" NPT taper
Options	G Gold-plated contacts for low current SG Degreased for applications with oxygen T... Set-point rising to the required value (ex. T500 rising set-point adjustment at -500 mbar) T...D Set-point falling to the required value (ex. T750D falling set-point adjustment at -750 mbar) CAP. 3 Execution suitable for CAP. 3

### 一般规格 / GENERAL SPECIFICATIONS

型号 MODEL	调整的相对压力范围 ADJUSTMENT RELATIVE PRESSURE RANGE mbar	尺寸 DIMENSIONS mm		最大静压 MAX. STATIC PRESSURE bar	25°C 时公差 TOLERANCE AT 25°C mbar	25°C 时最大固定磁滞 MAX. FIXED HYSTERESIS AT 25°C mbar	配置 EXECUTION	本体 BODY
		用于保护帽 1 VERSION FOR CAP. 1	用于保护帽 3 VERSION FOR CAP. 3					
VCN2	-200 / -900	40	46	20	± 50	20	隔膜 Diaphragm	黄铜 Brass
VCN2...W	-200 / -900	40	46	20	± 50	20	隔膜 Diaphragm	316 不锈钢配置本体 S.s. 316

Elettrotec保留未经事先通知更改产品技术数据或暂停生产的权利。该压力控制器触点受到强烈冲击或震动时可能会被损坏。用户有责任对我们的产品是否适合特定应用进行测试，例如，材料的兼容性测试。仅在现场试验中得到证实的使用才是适当的。该样本中的技术信息基于产品开发过程中的测试和经验值的积累，他们可能并不适用于所有情况。

Elettrotec reserves the right to technical data of change to the products or halt production without prior notice. The pressure controller contacts can be damaged when subject to strong shocks or high vibration. It is the responsibility of the user to test the suitability of our products for the particular application, for example, the verification of material compatibility. The use may only be appropriate if proven in field tests. The technical information in this catalogue are based on tests made during product development and based on empirically gathered values. They may not be applicable in all cases.

# 常规技术参数 GENERAL TECHNICAL DATA

隔膜式压力控制器，常闭触点  
DIAPHRAGM PRESSURE CONTROLLER, NC CONTACT

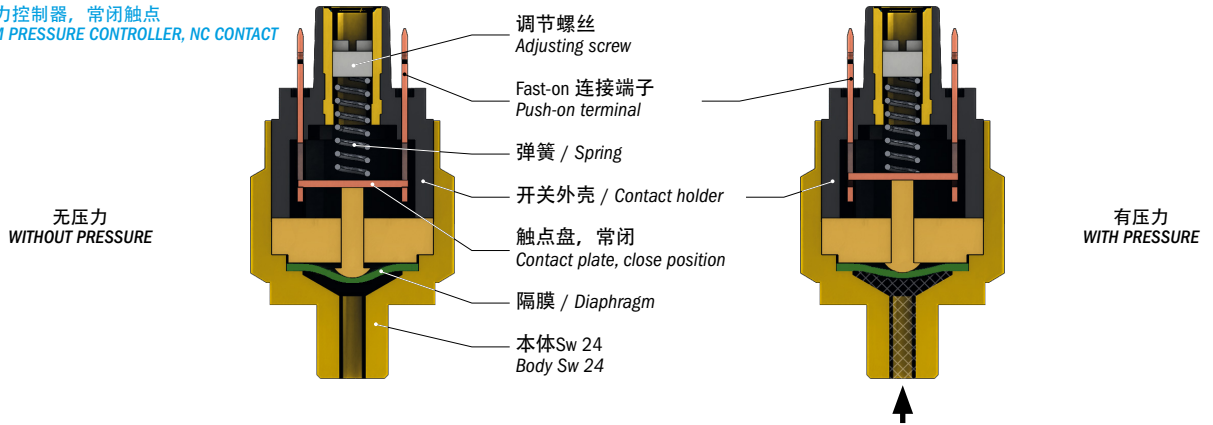

隔膜式压力控制器，常开触点  
DIAPHRAGM PRESSURE CONTROLLER, NO CONTACT

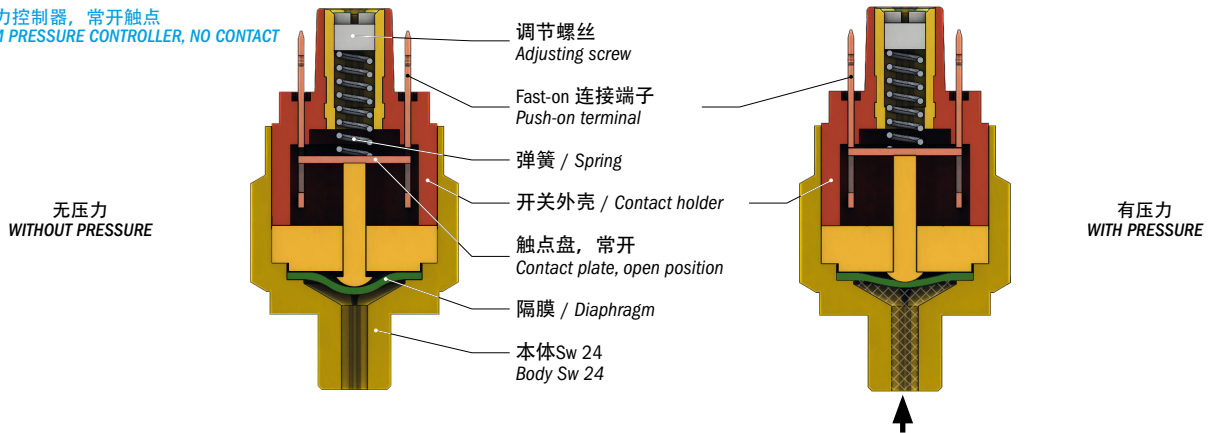

建议紧固力矩 / RECOMMENDED TIGHTENING TORQUES

黄铜 / Brass		镀锌钢 Zinc plated steel		316不锈钢 / S.s. 316	
螺纹 Thread	建议紧固力矩* Recommended tightening torque Nm	螺纹 Thread	建议紧固力矩* Recommended tightening torque Nm	螺纹 Thread	建议紧固力矩* Recommended tightening torque Nm
R18	17	R18	22	R18	24
18K	17	18K	22	18K	24
18NPT	17	18NPT	22	18NPT	24
5/8UNF	30	5/8UNF	40	5/8UNF	45
R12	40	R12	55	R12	60
R14	25	R14	35	R14	40
14K	25	14K	35	14K	40
14NPT	25	14NPT	35	14NPT	40
M10	18	M10	25	M10	30
M12	23	M12	32	M12	35
10K	18	10K	25	10K	30
34K	50	34K	70	34K	80

电气触点分类 / ELECTRICAL CONTACTS APPLIED









触点材料 / Contacts			DIN-EN-60947-5-1 标准 Standard DIN-EN-60947-5-1	IEC60617电气符号 Symbol IEC 60617
NO	NO 常开 NO normally open	单刀单掷 SPST	X	
NC	NC 常闭 NC normally closed	单刀单掷 SPST	Y	
SC	SC 可切换 CO change over (snap action)	单刀双掷 SPDT	C	

\* 不适当的扭矩可能会影响开关的机械寿命。相关法规以多种方式表达。通过改变用于制造开关本体的材料类型，也将改变紧固扭矩。

\* Improper torque may affect the mechanical life of the switch. The relevant legislation has been expressed in various ways. By varying the type of material used to make the switch body, will also vary the tightening torque.

# 真空控制器 / VACUUM CONTROLLERS

## 电气保护 ELECTRIC PROTECTIONS

		VCN	VCM	VS	VSM	VMC
<b>页 / Page</b>		59	61	63	65	67
电气保护IP54 <i>IP 54 electric protection</i>	保护帽1 CAP. 1 	●	●			
	保护帽10 CAP. 10 	●	●			
	保护帽12 CAP. 12 				●	
	保护帽16 CAP. 16 			●		
电气保护IP65 <i>IP 65 electric protection</i>	保护帽3 CAP. 3 		●			
	保护帽13 CAP. 13 			●		
	DIN 40050连接器 <i>DIN 40050 connector</i> 				●	●
电气保护IP67 <i>IP 67 electric protection</i>	保护帽14+飞线+连接器 CAP. 14 + flying leads + connector 			●		
	M12连接器 / M12 connector 			●		

## 技术参数 TECHNICAL DATA

		VCN	VCM	VS	VSM	VMC
电源 / <i>Power supply</i>	12 Vac/dc	●	●	●	●	●
	24 Vac/dc	●	●	●	●	●
	48 Vac/dc	●	●	●	●	●
	110 Vac/dc			●	●	●
	220 Vac/dc			●	●	●
	250 Vac/dc			●	●	●
最大电流 / <i>Max. current</i>	< 30 mA	●	●	●	●	●
	0.5 A	●	●			
	3 A					●
	6 A			●	●	
镀银触点 / <i>Silver plated contacts</i>		●	●	●	●	●
镀金触点 / <i>Gold plated contacts</i>		●	●	●	●	●
固定复位差 / <i>Fixed hysteresis</i>		●	●	●		●
可调复位差 / <i>Adjustable hysteresis</i>					●	
本体 Ch 24 / <i>Body 24 AF</i>		●	●	●		
本体 Ch 27 / <i>Body 27 AF</i>					●	

Elettrotec保留未经事先通知更改产品技术数据或暂停生产的权利。该压力控制器触点受到强烈冲击或震动时可能会被损坏。用户有责任对我们的产品是否适合特定应用进行测试，例如，材料的兼容性测试。仅在现场试验中得到证实的使用才是适当的。该样本中的技术信息基于产品开发过程中的测试和经验值的积累，他们可能并不适用于所有情况。

Elettrotec reserves the right to technical data of change to the products or halt production without prior notice. The pressure controller contacts can be damaged when subject to strong shocks or high vibration. It is the responsibility of the user to test the suitability of our products for the particular application, for example, the verification of material compatibility. The use may only be appropriate if proven in field tests. The technical information in this catalogue are based on tests made during product development and based on empirically gathered values. They may not be applicable in all cases.